

Pixsy
ELECTRONICS

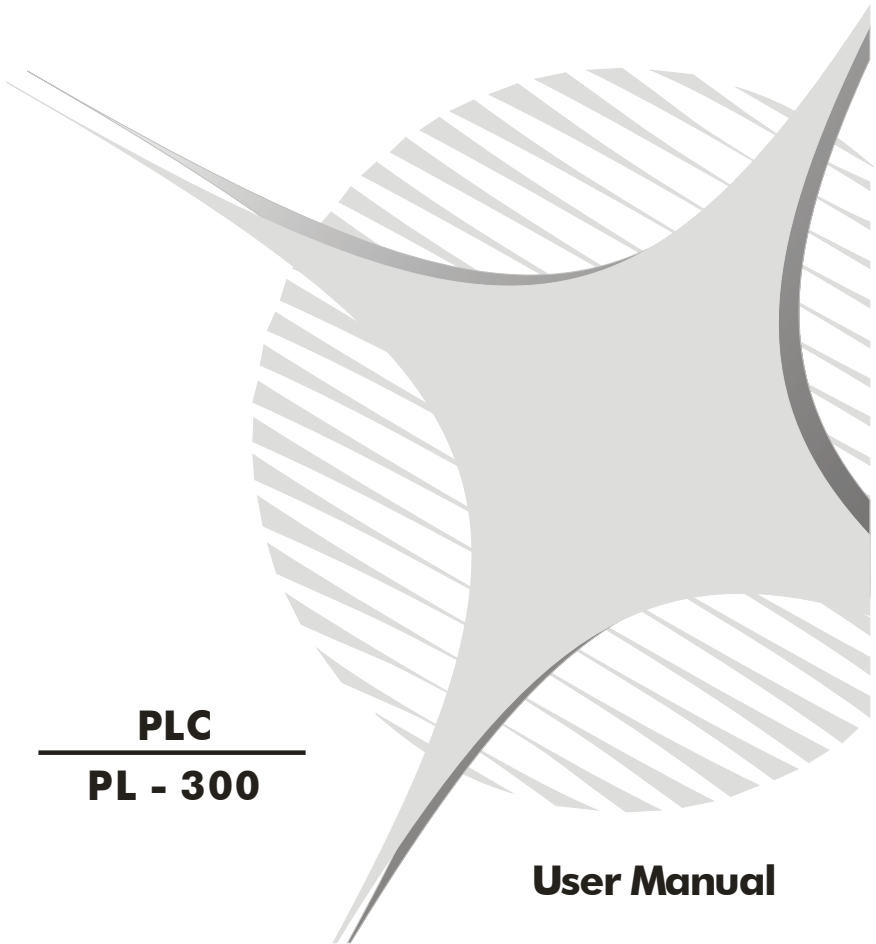

PLC

PL - 300

User Manual

Contents list

1. Data acquisition module PL300	3
1.1 Introduction	3
1.2 Frontal panel.....	5
1.3 Size and installation.....	6
1.4 Electrical wirings.....	7
1.4.1 Examples of sensors connections to analog inputs PL300	10
1.4.2 Example of connection to RS485 and to a Master unit	11
1.5 Select type of linear output.....	12
1.6 Communication address	13
1.7 List of configuration parameters	14
1.8 Configuration of alarms for analog inputs.....	23
1.9 Tuning (Automatic setting of PID parameters)	26
1.10 Protocol Modbus RTU	27
1.11 Addresses WORD/BIT PL300 for Modbus RTU.....	28

1. Data acquisition module PL300

1.1 Introduction

The module PL300 is a powerful data acquisition module which can be used as I/O interface for Industrial terminals or SCADA

It allows to measure temperature values with different types of thermocouples and thermoresistance and/or it enables the acquisition of normalized signals by means of a 14 bit converter. The 6 digital inputs can get eventual alarm notices and the 2 linear outputs (isolated 14 bit) can drive different types of transducers. Twelve relay outputs (2 relays 8A + 10 relays 5A / 230VAC resistive) are available.

Beside the mixed acquisition system, a great advantage of this module PL300, compared to any PC board, is the possibility to place it close to the plant and let it communicate with the central unit via RS485 or Current loop 20mA (both interfaces are galvanic isolated). This means a higher immunity to any external noise, beside the possibility to simplify the wirings.

The module has been designed and built in compliance with current CE standards and it widely meets the safety requirements for light and heavy industry.

General features	
Operating conditions	0-45 °C, humidity 35..95rH%
Box	Standard DIN 43880 for DIN rail EN500200 Self-extinguish Noryl 94V1
Protection	Box IP30, Terminal blocks IP20
Weight	About 400 gr.
Size	90 x 160x53 (depht) mm

Hardware data	
Power supply	12 ... 24 Vac/Vdc 10VA (with AC supply, please use a separate isolation transformer 20VA for each module)
Analog inputs (selectable via software)	AN1÷AN4 <ul style="list-style-type: none">- Thermocouples K, S, T, R, J, E- Thermoresistance PT100, NI100, PT500,PT1000 (accuracy 0.2% ± 1 digit)- Voltage 0-1V,0-10V,0-50mV (accuracy 0.2% ± 1 digit)- Current 0-20mA, 4-20mA (accuracy 0.1% ± 1 digit)
Digital inputs	I5÷I10 <ul style="list-style-type: none">- PNP

Relay outputs ¹	U1÷U12	- U1÷U2 relay 8A-230Vac (contact NO and NC) - U3÷U12 relay 5A-230 Vac
Uscite SSR ²	SSR1÷SSR4	- Supply 10-32 Vdc - Max 100mA for single output
Configurable linear outputs (selectable via software and by internal dip-switch)	OUT1÷OUT2	- Logic 0-14V (20mA max.) - Voltage 0-10V (12bit/20mA max.) - Current 4-20mA (12bit) Galvanic isolated from power and from inputs, but not isolated themselves
Serial port	COM1 COM2	- RS485 available on terminal block and plug connector/ 8 poles Galvanic isolated - RS232 MODBUS on plug connector 8 poles (not isolated)

Software data	
PID and ON/OFF algorithms	Up to 4 control loops ON/OFF control or PID with Autotuning function (automatic setting of PID parameters)
Motorised valves control	Using two coupled relay outputs (U1-U2, U3-U4, U5-U6, U7-U8) it is possible to drive the opening of motorised valves. Position control is performed by measuring the time of opening and closing impulses.
Time proportioning output	In case any value is controlled applying ON/OFF modulation, some outputs can be activated for time-proportioning ON/OFF operating: period (sec.) and duty-cycle of output signal must be defined and the PL300 generates it automatically
Communication protocol	Modbus RTU. Selectable Baud-rate and answer delay

¹ U1÷U4 available only on PL300-10AD

² Available only on PL300-30AD.

1.2 Frontal panel

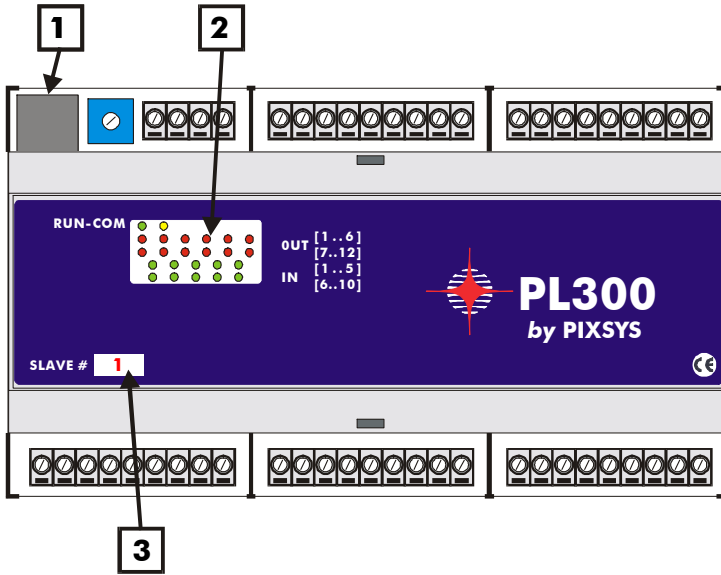

Reference	Description
1	Plug connector – communication COM1, COM2
2	<p>RUN green led</p> <ul style="list-style-type: none"> ON → when PL300 is working Fast flashing → (0,2sec ON /0,2sec OFF) if main program is not available and only boot program is stored on PL300 <p>COM led yellow</p> <ul style="list-style-type: none"> ON → for 50ms during transmission of frames on serial ports ON → during the programming (update of main program) <p>OUT 1..12 red leds → ON if output is active</p> <p>IN 1..10 green leds → ON if digital input is active, blinking led for analog input out of range.</p>
3	Slave number of module PL300.

1.3 Size and installation

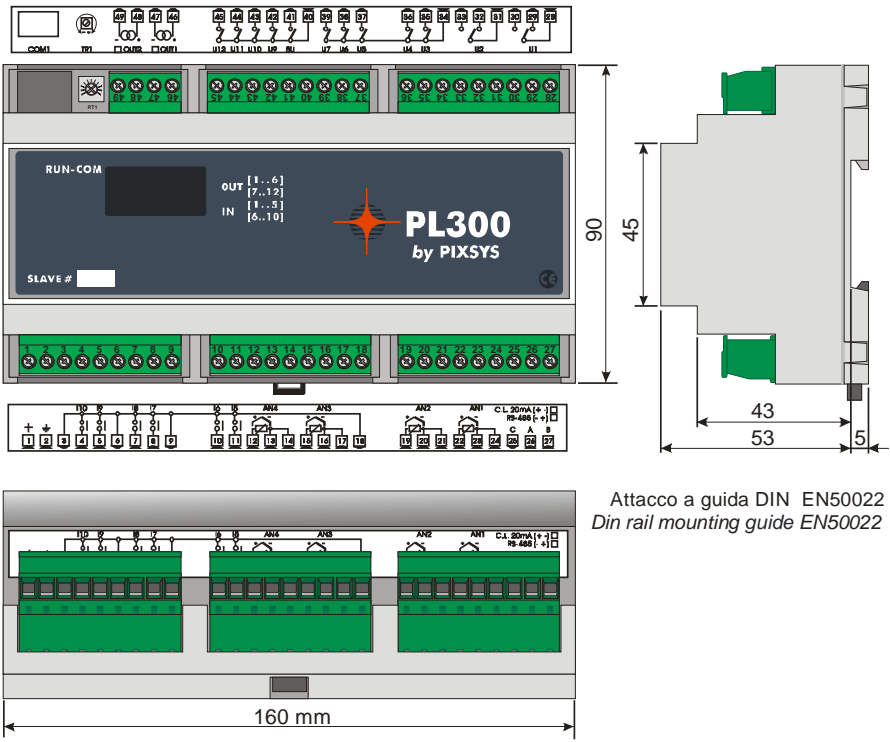

Attacco a guida DIN EN50022
Din rail mounting guide EN50022

1.4 Electrical wirings

N°	Name	Description
1	+	Supply 12÷24V AC\DC 10VA. To improve immunity to noises, the employ of the dedicated transformer secondary is highly recommended.
2	⏏	
25	C	Reference signal of serial communication port
26	A	RS485- / C.L.20mA+
27	B	RS485+ / C.L.20mA-
22	AN1+	Positive signal for analog input AN1 (+Tc).
23	AN1-	Reference signal analog input AN1 (-Tc).
24	AN1C	Compensation PT100. For 3-wire PT100 connect compensation wire to this terminal.
19	AN2+	Positive signal for analog input AN2 (+Tc).
20	AN2-	Reference signal for analog input AN2 (-Tc).
21	AN2C	Compensation PT100. For 3-wire PT100 connect compensation wire to this terminal.
15	AN3+	Positive signal for analog input AN3 (+Tc).
16	AN3-	Reference signal for analog input AN3 (-Tc).
17	AN3C	Compensation PT100. For 3-wire PT100 connect compensation wire to this terminal.
12	AN4+	Positive signal for analog input AN4 (+Tc).
13	AN4-	Reference signal for analog input AN4 (-Tc)
14	AN4C	Compensation PT100. For 3-wire PT100 connect compensation wire to this terminal.
3	COM INPUT	Common positive signal for digital inputs. Connect this signal to one of the digital inputs (I5÷I10) or to terminal “+” of analog inputs (AN1÷AN4 if configured via software as digital input), to activate the input (the relevant led switches on). These pins may be used to provide power supply to analog sensors (voltage or current) Input voltage is not stabilized.
6		
9		
18		

N°	Name	Description
11	I5	Digital input
10	I6	Digital input
8	I7	Digital input
7	I8	Digital input
5	I9	Digital input
4	I10	Digital input

To activate digital inputs, short-circuit signal COM INPUT on the terminals of input. Leds ON mean that output is active

PL300-10AD Version 12 relay outputs		
28	U1 Com	Common contact relay U1.
29	U1 N.C.	Contact relay U1 N.C.
30	U1 N.O.	Contact relay U1 N.O.
31	U2 Com	Common contact relay U2.
32	U2 N.C.	Contact relay U2 N.C.
33	U2 N.O.	Contact relay U2 N.O.
34	U3÷U7 Com	Common contact relays U3÷U7.
35	U3 N.O.	Contact relay U3 N.O.
36	U4 N.O.	Contact relay U4 N.O.
37	U5 N.O.	Contact relay U5 N.O.
38	U6 N.O.	Contact relay U6 N.O.
39	U7 N.O.	Contact relay U7 N.O.
40	U8÷U12Com	Common contact relays U8÷U12.
41	U8 N.O.	Contact relay U8 N.O.
42	U9 N.O.	Contact relay U9 N.O.
43	U10 N.O.	Contact relay U10 N.O.
44	U11 N.O.	Contact relay U11 N.O.
45	U12 N.O.	Contact relay U12 N.O.
46	OUT1+	Positive signal linear output OUT1.
47	OUT1-	Reference linear output OUT1.
48	OUT2+	Positive signal linear output OUT2
49	OUT2-	Reference linear output OUT2

8A ÷ 230Volt resistive

5A ÷ 230Volt resistive

0..10 Volt
4..20 mA
Logic 0-15 Volt

PL300-30AD Version 8 relay outputs + 4 SSR outputs				
No.	Name	Description		
28	---	No connection	100mA ÷ 24Volt Max.	
29	SSR2	Output SSR no. 2 (NPN).		
30	SSR1	Output SSR no. 1 (NPN).		
31	---	No connection		
32	SSR4	Output SSR no. 4 (NPN).		
33	SSR3	Output SSR no. 3 (NPN).		
35	12/24V ³	Positive signal for SSR outputs.	10 ÷ 32 Vdc	
36		Reference signal for SSR outputs.		
34	U5÷U7 Com	Common contact relays U5÷U7.	5A ÷ 230Volt resistive	
37	U5 N.O.	Relay U5 contact N.O.		
38	U6 N.O.	Relay U6 contact N.O.		
39	U7 N.O.	Relay U7 contact N.O.		
40	U8+U12Com	Common contact for relays U8+U12.		
41	U8 N.O.	Relay U8 contact N.O.		
42	U9 N.O.	Relay U9 contact N.O.		
43	U10 N.O.	Relay U10 contact N.O.		
44	U11 N.O.	Relay U11 contact N.O.		
45	U12 N.O.	Relay U12 contact N.O.		
46	OUT1+	Positive OUT1 linear		0..10 Volt 4..20 mA Logic 0-15 Volt
47	OUT1-	Reference OUT1 linear		
48	OUT2+	Positive OUT2 linear		
49	OUT2-	Reference OUT2 linear		

³ Up to max. 80 mA, to supply SSR outputs it is possible to use the common positive signal of digital inputs (pins 3,6,9,18) and the negative signal of general power supply (pin 2).

No.	Name	Description
COM	COM1 RS485	<p>PL250 COM plug-8</p> <p>COM1 RS485</p> <p>8 - 7 - 6 - 5 - 4 - COM1-A RS- (MORS. 26) 3 - 2 - COM1-C RS REF (MORS. 25) 1 - COM1-B RS+ (MORS. 27)</p>
	COM2 RS232	<p>PL250 COM plug-8</p> <p>COM2 RS232</p> <p>8 - 7 - 6 - COM2- RX232 5 - COM2- TX232 4 - 3 - COM2- GND232 2 - 1 -</p>

1.4.1 Examples of sensors connections to analog inputs PL300

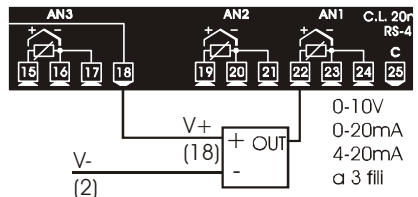
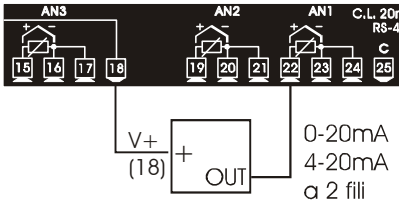

1.4.2 Example of connection to RS485 and to a Master unit

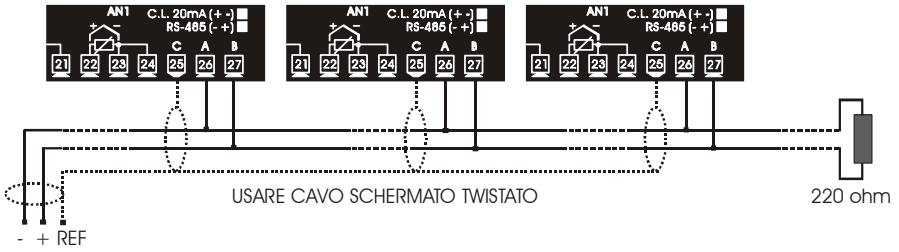

1.5 Select type of linear output

PL300 is provided with 2 linear outputs (OUT1, OUT2) which must be configured via software and manually by configuring 2 dip-switches on board:

- Disconnect power supply PL300.
- Use a screwdriver to remove the upper cover of PL300
- Set dip SW1 (for OUT1) and SW2 (for OUT2) as shown here below to configure the output



- Replace the upper cover and restart PL300.
- Dip SW1-1 and SW2-1 are used to set the communication address of PL300, not for outputs selection.

1.6 Communication address

Two dip-switches allow to set the address of module PL300 to communicate with a Master device. Four combinations of jumpers are available, therefore to connect more than 4 modules to the network it is necessary to modify the value of offset parameter. The address of the module is given as follows:

MODULE ADDRESS = ADDRESS OFFSET + COMBINATION OF DIP-SWITCHES

The address offset is stored on memory of PL300 (default is 0) and it can be modified on Modbus word 5.

To set the address proceed as follows:

- Disconnect power supply
- Remove upper cover of PL300
- Set dip SW1-1 and SW2-1 as described below : the obtained value must be added to offset value in order to get the complete address.

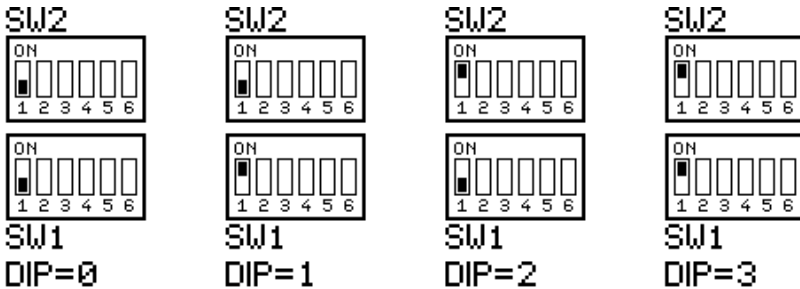

- Place cover and restart PL300.

1.7 List of configuration parameters

Configuration parameters are stored on EEPROM, therefore they will not be lost in case of power failure. Each parameter can be written max. 100.000 times, therefore avoid useless writings of parameters. At each modify of parameters, PL300 starts the initialization both of inputs reading and outputs rate. This stage lasts about 2 seconds. Some parameters are handled as hexadecimal digits: the parameter is divided into 4 nibbles (groups of 4 bit) to be represented.

“1st digit” = bits 12÷15

“2nd digit” = bits 8÷11

“3rd digit” = bits 4÷7

“4th digit” = bits 0÷3 (bit 0 is meant as less significant)

P-01	Configuration analog input AN1
P-02	Configuration analog input AN2
P-03	Configuration analog input AN3
P-04	Configuration analog input AN4
	<i>These parameters define the type of sensor connected to analog input AN1, AN2, AN3, AN4.</i>
0	No connected sensor (Input used as digital input)
1	Type K (-270/1370°C)
2	Type S (-50/1760°C)
3	Type T (-270/400°C)
4	Type R (-50/1760°C)
5	Type J (-210/1200°C)
6	Type E (-270/1000°C)
7	PT100 (-200/800°C)
8	NI100 (-60/180°C)
9	-----
10	Voltage 0..1V
11	Voltage 0..10V
12	Current 0..20mA
13	Current 4..20mA
14	Voltage 0..50mV
15	PT500 with resistor 506 Ohm 0,1% parallel (-200/350°C)
16	NI1000 with resistor 470 Ohm 0.1% parallel (-60/150°C)
P-05	Lower limit scale AN1 (-3000.0 + 3000.0)
P-06	Upper limit scale AN1 (-3000.0 + 3000.0)
	<i>These parameters define the numeric limits of analog conversion for signal connected to AN1 (only if configured for current/voltage).</i>

P-07	Lower limit scale AN2 (-3000.0 + 3000.0)
P-08	Upper limit scale AN2 (-3000.0 + 3000.0)
	<i>These parameters define the numeric limits of analog conversion for signal connected to AN2 (only if configured for current or voltage).</i>
P-09	Lower limit scale AN3 (-3000.0 + 3000.0)
P-10	Upper limit scale AN3 (-3000.0 + 3000.0)
	<i>These parameters define the numeric limits of analog conversion for signal connected to AN3 (only if configured for current/voltage).</i>
P-11	Lower limit scale AN4 (-3000.0 + 3000.0)
P-12	Upper limit scale AN4 (-3000.0 + 3000.0)
	<i>These parameters define the numeric limits of analog conversion for signal connected to AN4 (only if configured for current/voltage)</i>
P-13	Calibration OFFSET AN1 (-999.9 ÷ 999.9)
P-14	Calibration GAIN AN1 (-999.9 + 999.9%)
P-15	Calibration OFFSET AN2 (-999.9 ÷ 999.9)
P-16	Calibration GAIN AN2 (-999.9 ÷ 999.9%)
P-17	Calibration OFFSET AN3 (-999.9 + 999.9)
P-18	Calibration GAIN AN3 (-999.9 ÷ 999.9%)
P-19	Calibration OFFSET AN4 (-999.9 ÷ 999.9)
P-20	Calibration GAIN AN4 (-999.9 + 999.9%)
	<i>These parameters define the calibration for conversion of AN1, AN2, AN3, AN4 to correct any eventual reading mistake. The relative formule is as follows: Value AN1 = Value AN1 + (Value AN1 * GAIN calibration AN1) / 100.0 + OFFSET Calibration</i>
P-21	Software filter (1..20sec)
	<i>Filter value on conversion of AN1, AN2, AN3 , AN4</i>
P-22	Type of linear output OUT1
P-23	Type of linear output OUT2
	<i>Type of used linear output. Set the dip-switches correctly. Time for SSR output is set on P-24 (OUT1) and P-25 (OUT2).</i>
0	Not used
1	Logic 0-14V(30mA)
2	Voltage 0...10V
3	Current 4..20mA
4	-----
5	SSR time proportioning (Period is set on parameters P-24 / P-25)

P-24	Time for servo-control 1 (0..600 sec.)
	<i>Time for servo-control related to Open/Close U1,U2 or period for time proportioning output U1(U2) or SSR1 or OUT1 (see P-28)</i>
P-25	Time for servo-control 2 (0..600 sec.)
	<i>Time for servo-control related to Open/Close U3,U4 or period for time proportioning output U3(U4) or SSR2 or OUT2 (see P-29)</i>
P-26	Time for servo-control 3 (0..600 sec.)
	<i>Time for servo-control related to Open/Close U5,U6 or period for time proportioning output U5(U6) or SSR3 (see P-30)</i>
P-27	Time for servo-control 4 (0..600 sec.)
	<i>Time for servo-control related to Open/Close U7,U8 or period for time proportioning output U7(U8) or SSR4 (see P-31)</i>
P-28	SERVO-CONTROL1 Operating mode for relay output U1,U2 or SSR1
0	Disabled (U1-U2 or SSR1 free)
1	Combined operating of U1-U2 for function OPEN (U1)-CLOSE (U2)
2	Time proportioning U1 with contact N.O. U2 free
3	Time proportioning U1 with contact N.O. Time proportioning U2 with contact N.C
4	U1 ON/OFF + contact N.O. U2 free
5	U1 ON/OFF + contact N.C. U2 free
6	SSR1 time proportioning
7	SSR1 ON/OFF
P-29	SERVO-CONTROL2 Operating mode for relay output U3,U4 or SSR2
0	Disabled (U3 – U4 or SSR2 free)
1	Combined operating of U3-U4 for function OPEN (U3)-CLOSE (U4)
2	Time proportioning U3 with contact N.O. U4 free
3	Time proportioning U3 with contact N.O. Time proportioning U4 with contact N.C.
4	U3 ON/OFF + contact N.O. U4 free
5	U3 ON/OFF + contact N.C. U4 free
6	SSR2 time proportioning
7	SSR2 ON/OFF

P-30	SERVO-CONTROL3 Operating mode for relay output U5,U6 or SSR3	
	0	Disabled (U5, U6 or SSR3 free)
	1	Combined action of U5-U6 for function OPEN (U5)-CLOSE (U6)
	2	Time proportioning U5 with contact N.O. U6 free
	3	Time proportioning U5 with contact N.O. Time proportioning U6 with contact N.C.
	4	U5 ON/OFF + contact N.O. U6 free
	5	U5 ON/OFF + contact N.C. U6 free
	6	SSR3 time proportioning
P-31	SERVO-CONTROL4 Operating mode for relay output U7,U8 or SSR4	
	0	Disabled (U7, U8 or SSR4 free)
	1	Combined action of U7-U8 for function OPEN (U7)-CLOSE (U8)
	2	Time proportioning U7 with contact N.O. U8 free
	3	Time proportioning U7 with contact N.O. Time proportioning U8 with contact N.C.
	4	U7 ON/OFF + contact N.O. U8 free
	5	U7 ON/OFF + contact N.C. U8 free
	6	SSR4 time proportioning
P-32	State of relay in off-line condition	
	<i>State of relays in case of communication failure with MASTER for over 60 seconds. Each bit of this parameter is related to the state of one relay: Bit0 → U1, Bit1 → U2, ... Bit11 →U12. Value 65535 desables this function.</i>	
	0	Open contact
1	Closed contact	

P-33	Configuration serial port COM1 (RS-485)
	<i>Switch off and restart the PL300 after entering of these settings.</i>
	1st Digit – BaudRate communication COM1
	0 9600 bits/sec
	1 19200 bits/sec
	2 38400 bits/sec
	2nd Digit – Data format for COM1
	0 8,N,1
	1 8,O,1
	2 8,E,1
	3 8,N,2
	4 8,O,2
	5 8,E,2
P-34	Answer delay COM1 (RS-485) 0..1000 msec
	<i>Set the minimum delay between end of serial reception of data from master and start of answer transmission from PL300.</i>
P-35	Reserved
P-36	Control action on analog inputs
	1st Digit – Control action analog input AN1
	2nd Digit – Control action analog input AN2
	3rd Digit – Control action analog input AN3
	4th Digit – Control action analog input AN4
	0 No control action
	1 ON/OFF
	2 P.I.D. direct (ex.: cooling)
	3 P.I.D. reverse (ex.: heating)

P-37	Control outputs	
	1st Digit – Control output AN1 analog input	
	0	Servo-control 1 (see parameter P-28)
	1	OUT1 (see parameter P-22)
	2	OUT2 (see parameter P-23)
	2nd Digit – Control output AN2 analog input	
	0	Servo-control 2 (see parameter P-29)
	1	OUT1 (see parameter P-22)
	2	OUT2 (see parameter P-23)
	3rd Digit – Control output AN3 analog input	
	0	Servo-control 3 (see parameter P-30)
	2	OUT1 (see parameter P-22)
	3	OUT2 (see parameter P-23)
	4th Digit – Control output AN4 analog input	
	0	Servo-control 4 (see parameter P-31)
	2	OUT1 (see parameter P-22)
	3	OUT2 (see parameter P-23)
P-38	Dead band PID control (or hysteresis ON/OFF) AN1 (-999.9÷999.9)	
P-39	Proportional band PID control AN1 (-999.9÷999.9)	
P-40	Integral time PID control AN1 (0÷10000 sec)	
P-41	Derivative time PID control AN1 (0÷1000.0 sec)	
P-42	Dead band PID control (or hysteresis ON/OFF) AN2 (-999.9÷999.9)	
P-43	Proportional band PID control AN2 (-999.9÷999.9)	
P-44	Integral time PID control AN2 (0÷10000 sec)	
P-45	Derivative time PID control AN2 (0÷1000.0 sec)	
P-46	Dead band PID control (or hysteresis ON/OFF) AN3 (-999.9÷999.9)	
P-47	Proportional band PID control AN3 (-999.9÷999.9)	
P-48	Integral time PID control AN3 (0÷10000 sec)	
P-49	Derivative time PID regolazione AN3 (0÷1000.0 sec)	
P-50	Dead band PID control (or hysteresis ON/OFF) AN4 (-999.9÷999.9)	
P-51	Proportional band PID control AN4 (-999.9÷999.9)	
P-52	Integral time PID control AN4 (0÷10000 sec)	
P-53	Derivative time PID control AN4 (0÷1000.0 sec)	
P-54	Use of variables on non-volatile RAM	
	1st Digit – Enable the functions related to words 164÷175	
	0	Functions disabled
	1	Functions enabled
	2nd Digit – Enable the functions related to words 176÷179	
	0	Functions disabled
	1	Functions enabled

P-55	Starting % output OUT1 (0.00÷100.00 %)
P-56	Starting % output OUT2 (0.00÷100.00 %)
P-57	Configuration of alarms for analog inputs AN1, AN2
	1st Digit – Configuration 1st alarm analog input AN1
	2nd Digit – Configuration 2nd alarm analog input AN1
	3rd Digit – Configuration 1st alarm analog input AN2
	4th Digit – Configuration 2nd alarm analog input AN2
	0 Disabled
	1 Independent alarm / over
	2 Independent alarm / under
	3 Upper deviation
	4 Lower deviation
	5 Band alarm / inside
	6 Band alarm / outside
	7 Lower deviation alarm disabled at starting <i>(Alarm is automatically enabled when value of analog input exceeds the alarm threshold added to value of hysteresis).</i>
P-58	Configuration of alarms for analog inputs AN3, AN4
	1st Digit – Configuration 1st alarm analog input AN3
	2nd Digit – Configuration 2nd alarm analog input AN3
	3rd Digit – Configuration 1st alarm analog input AN4
	4th Digit – Configuration 2nd alarm analog input AN4
	0 Disabled
	1 Independent alarm / over
	2 Independent alarm / under
	3 Upper deviation
	4 Lower deviation
	5 Band alarm / inside
	6 Band alarm / outside
	7 Lower deviation alarm disabled at starting <i>(Alarm is automatically enabled when value of analog input exceeds the alarm threshold added to value of hysteresis).</i>

P-59	Configuration of alarm outputs for analog inputs AN1, AN2*	
	1st Digit – 1st alarm analog input AN1	
	2nd Digit – 2nd alarm analog input AN1	
	3rd Digit – 1st alarm analog input AN2	
	4th Digit – 2nd alarm analog input AN2	
	0	No output
	1	U1/SSR1
	2	U2/SSR2
	3	U3/SSR3
	4	U4/SSR4
	5	U5
	6	U6
	7	U7
	8	U8
	9	U9
10	U10	
11	U11	
12	U12	
13	OUT1	
14	OUT2	
P-60	Configuration of alarm outputs for analog inputs AN3, AN4*	
	1st Digit – Output configuration for 1st alarm analog input AN3	
	2nd Digit – Output configuration 2nd alarm analog input AN3	
	3rd Digit – Output configuration 1st alarm analog input AN4	
	4th Digit – Output configuration 2nd alarm analog input AN4	
	0	No outputs
	1	U1/SSR1
	2	U2/SSR2
	3	U3/SSR3
	4	U4/SSR4
5	U5	
6	U6	
7	U7	
8	U8	
9	U9	
10	U10	

* Really outputs U1÷U4 are available on PL300-1XAD (12 relay OUT), SSR1÷SSR4 outputs are available on PL300-3XAD (4 SSR + 8 relay OUT).

	11	U11
	12	U12
	13	OUT1
	14	OUT2
P-61	Treshold 1st alarm analog input AN1 (-3000.0 ÷ 3000.0)	
P-62	Hysteresis 1st alarm analog input AN1 (0.0 ÷ 999.9)	
P-63	Treshold 2nd alarm analog input AN1 (-3000.0 ÷ 3000.0)	
P-64	Hysteresis 2nd alarm analog input AN1 (0.0 ÷ 999.9)	
P-65	Treshold 1st alarm analog input AN2(-3000.0 ÷ 3000.0)	
P-66	Hysteresis 1st alarm analog input AN2 (0.0 ÷ 999.9)	
P-67	Treshold 2nd alarm analog input AN2 (-3000.0 ÷ 3000.0)	
P-68	Hysteresis 2nd alarm analog input AN2 (0.0 ÷ 999.9)	
P-69	Treshold 1st alarm analog input AN3 (-3000.0 ÷ 3000.0)	
P-70	Hysteresis 1st alarm analog input AN3 (0.0 ÷ 999.9)	
P-71	Treshold 2nd alarm analog input AN3 (-3000.0 ÷ 3000.0)	
P-72	Hysteresis 2nd alarm analog input AN3 (0.0 ÷ 999.9)	
P-73	Treshold 1st alarm analog input AN4 (-3000.0 ÷ 3000.0)	
P-74	Hysteresis 1st alarm analog input AN4 (0.0 ÷ 999.9)	
P-75	Treshold 2nd alarm analog input AN4 (-3000.0 ÷ 3000.0)	
P-76	Hysteresis 2nd alarm analog input AN4 (0.0 ÷ 999.9)	
P-77	Define state and setpoint for control action on analog inputs	
	1st digit – Control action for analog input AN1	
	2nd digit – Control action for analog input AN2	
	3rd digit – Control action for analog input AN3	
	4th digit – Control action for analog input AN4	
	0	Control action is defined by bit no. 600, 601, 602 , 603 and by setpoint values written on words no. 158, 159, 160 ,161. Start/stop of control action and modify of setpoints both available via serial communication.
	1	Control action always activated. Setpoint values written on parameters P-78, P-79, P-80 e P-81 . Select this option if modify of setpoints by the operator is not required.
	2	Control action always activated. Setpoint values written on words no. 158, 159, 160, 161 and changeable via serial communication.
P-78	Control setpoint for analog input AN1 (-3000.0 ÷ 3000.0)	
P-79	Control setpoint for analog input AN2 (-3000.0 ÷ 3000.0)	
P-80	Control setpoint for analog input AN3 (-3000.0 ÷ 3000.0)	
P-81	Control setpoint for analog input AN4 (-3000.0 ÷ 3000.0)	

1.8 Configuration of alarms for analog inputs

For each analog input, two alarms can be used and their operating is depending on the values of parameters P-57 to P-76. The tables below show the different operations available for alarms.

INDEPENDENT ALARM / OVER

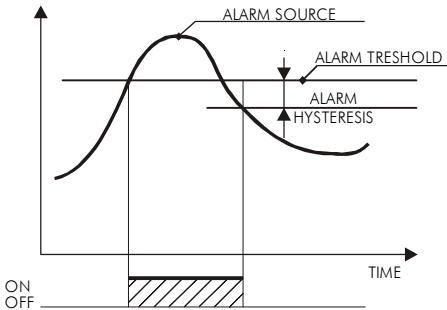

Max. treshold for the alarm source
(one of the analog inputs).

INDEPENDENT ALARM / UNDER

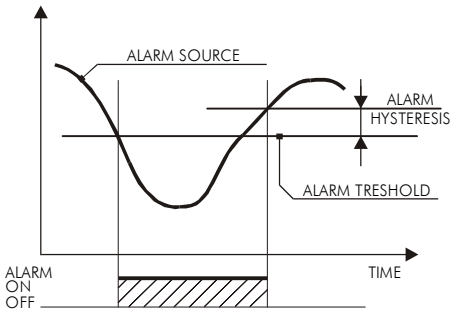

Minimum treshold for the alarm
source.

DEVIATION HIGH ALARM

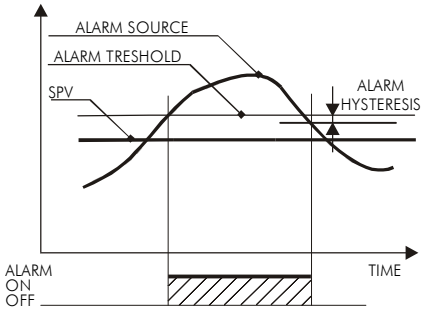

DEVIATION LOW ALARM

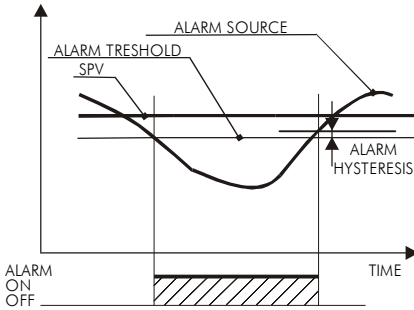

BAND ALARM / INSIDE

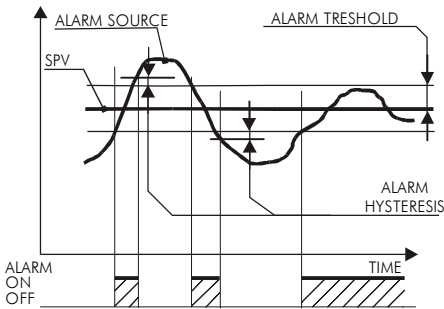

BAND ALARM / OUTSIDE

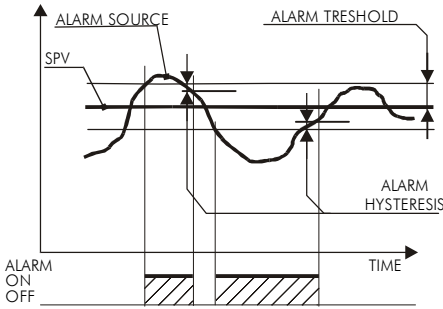

DEVIATION LOW ALARM - DISABLED AT STARTING

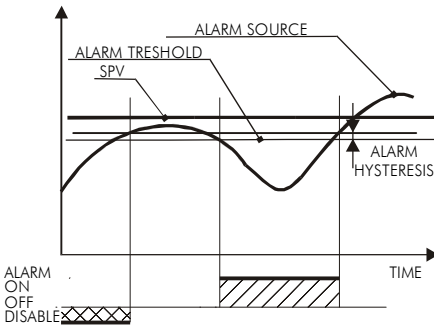

This alarm is disabled at the starting of PL300 and it is automatically activated when the alarm source exceeds the alarm treshold of a value which is equal to the hysteresis. Then the alarm works like the above described “deviation low alarm”.

1.9 Tuning (Automatic setting of PID parameters)

In Tuning action the characteristics of the controller are matched to those of the process being controlled in order to obtain:

- stable “straight-line” control of the temperature at setpoint without fluctuations
- no overshoot or undershoot of the temperature at setpoint
- quick response to deviations from the setpoint caused by external disturbances, thereby restoring the temperature rapidly to the setpoint value

Tuning involves calculating and setting the value of the following parameters:

- Proportional band (The bandwidth in display units over which the output power is proportioned between minimum and maximum)
- Integral time (determines the time taken by the controller to remove steady-state error signals)
- Derivative time (determines how strongly the controller will react to the rate-of-change of the measured value)
- Servo-control time (determines the cycle time for time proportioning output)
For management of motorized valves (Open/Close), time is not rated.

1.10 Protocol Modbus RTU

Module PL300 is conceived for connection to SCADA systems or Terminals via Modbus RTU. Serial communication enables the programming of parameters, configuration of I/O, reading of analog/digital inputs and outputs control.

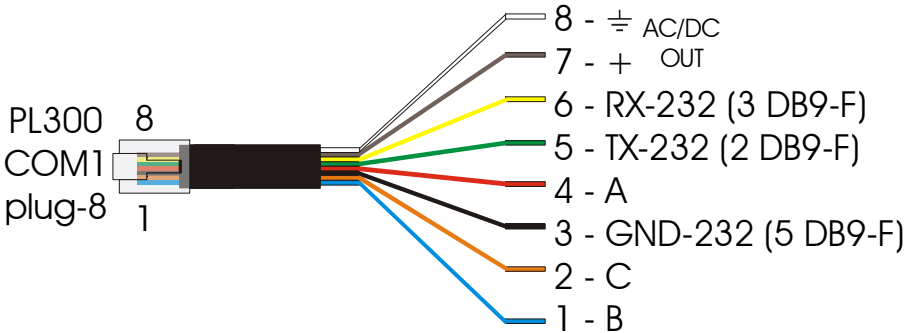

Features of protocol Modbus RTU	
Baud-rate	COM1 ->9600 baud (Default: see parameter P-33) COM2 ->19200 baud
Format	8,N,1 = 8bit, no parity, 1stop ((Default: see parameter P-33)
Supported functions	BITS READING (0x01, 0x02) WORDS READING (max 30 word) (0x03, 0x04) SINGLE BIT WRITING (0x05) SINGLE WORD WRITING (0x06) MULTIPLE BITS WRITING (0x0F) MULTIPLE WORDS WRITING (max 30 word) (0x10)
Error codes	ILLEGAL FUNCTION CODE (0x01) ILLEGAL DATA ADDRESS (0x02) ILLEGAL DATA VALUE (0x04)
Broadcast	Simultaneous writing to all connected slaves by address 0x00 , no answer from slaves
Polling of unknown slave address	Polling address 0xFF ; any connected slave answers.

1.11 Addresses WORD/BIT PL300 for Modbus RTU

The following tables contain all data (words and bits) which may be handled by Modbus protocol. The tables report reading and writing features as well as the value assumed at the starting of PL300. According to initialization value assumed at starting, the following type of value are possible:

1. **“EEP”** value stores on Eeprom memory and kept also in case of power failure
2. **“TAMP”** value stored on non-volatile RAM memory. Also these data are stored in case of power failure (approx. 4 months)
3. **“?”** These values are not given at the starting of PL300
4. **Numeric value:** the value assumed at starting of PL300 is the one which is reported in the table.

WORD			
MODBUS ADDRESS	Description	READ/ WRITE	RESET VALUE
0	Type of device	R	20
1	Software version PL300	R	100
5	Slave address MODBUS protocol	R/W	EEP
96	Value of linear output OUT1 (Range 0-10000)	R	P-55
97	Value of linear output OUT2 (Range 0-10000)	R	P-56
98	Serial transmission counter	R/W	0
99	Reset monitor (force to “0” at reset)	R/W	0
100	Value analog input AN1	R	?
101	Value analog input AN2	R	?
102	Value analog input AN3	R	?
103	Value analog input AN4	R	?
104	Value digital inputs (bit0 → I1, ..., bit9 → I10)	R	?
105	Status relay outputs (bit0 → U1, ..., bit11 → U12)	R	?
106	Temperature cold junction PL300	R	?
107	Flag for module status (1 = error/fail) Bit 0 → input AN1 out of range Bit 1 → input AN2 out of range Bit 2 → input AN3 out of range Bit 3 → input AN4 out of range Bit 4 → internal eeprom error Bit 5 → error on configuration parameters Bit 6 → error on calibration parameters Bit 7 → error on RAM memory data (TAMP) Bit 8 → error internal clock	R	?

WORD			
MODBUS ADDRESS	Description	READ/ WRITE	RESET VALUE
108	Alarms status analog inputs (bit0 → alarm no.1 AN1, bit1 → alarm no.2 AN1,...., bit7 → alarm no.2 AN4)	R	?
109	Timer (minutes) for closing of relay U1/SSR1	R/W	TAMP
110	Timer (minutes) for closing of relay U2/SSR2	R/W	TAMP
111	Timer (minutes) for closing of relay U3/SSR3	R/W	TAMP
112	Timer (minutes) for closing of relay U4/SSR4	R/W	TAMP
113	Timer (minutes) for closing of relay U5	R/W	TAMP
114	Timer (minutes) for closing of relay U6	R/W	TAMP
115	Timer (minutes) for closing of relay U7	R/W	TAMP
116	Timer (minutes) for closing of relay U8	R/W	TAMP
117	Timer (minutes) for closing of relay U9	R/W	TAMP
118	Timer (minutes) for closing of relay U10	R/W	TAMP
119	Timer (minutes) for closing of relay U11	R/W	TAMP
120	Timer (minutes) for closing of relay U12	R/W	TAMP
150	Setting of servo control 1 output (Range 0-10000)	R/W	0
151	Setting of servo control 2 output (Range 0-10000)	R/W	0
152	Setting of servo control 3 output (Range 0-10000)	R/W	0
153	Setting of servo control 4 output (Range 0-10000)	R/W	0
154	Setting of linear output OUT1 (Range 0-10000)	R/W	P- 55
155	Setting of linear output OUT2 (Range 0-10000)	R/W	P- 56
156	Setting relay outputs (bit0 → U1,...., bit11 → U12)	R/W	0
157	Enable relay modify via serial communication 1→ enable, 0→desable bit0 → U1,...., bit11 → U12. Only relays having bit=1 will assume the entered value by parameter 156	R/W	0
158	Control setpoint AN1	R/W	TAMP
159	Control setpoint AN2	R/W	TAMP
160	Control setpoint AN3	R/W	TAMP
161	Control setpoint AN4	R/W	TAMP
162	Control Run/Stop AN1÷AN4 (bit0→AN1,...., bit3→AN4 1=RUN)	R/W	TAMP
163	Start Auto-tuning AN1÷AN4 (only for reverse P.I.D.) (bit0→AN1,...., bit3→AN4 1=START) After completing the routine, PL300 will reset to 0 the bit related to the input which has been processed.	R/W	TAMP

WORD			
MODBUS ADDRESS	Description	READ/ WRITE	RESET VALUE
164	Select source analog input for control loop 1 0=AN1, 1=AN1, 2=AN2, 3=AN3, 4=AN4.	R/W	TAMP
165	Select source analog input for control loop 2 0=AN2, 1=AN1, 2=AN2, 3=AN3, 4=AN4.	R/W	TAMP
166	Select source analog input for control loop 3 0=AN3, 1=AN1, 2=AN2, 3=AN3, 4=AN4.	R/W	TAMP
167	Select source analog input for control loop 4 0=AN4, 1=AN1, 2=AN2, 3=AN3, 4=AN4.	R/W	TAMP
168	Select source setpoint for control loop 1 0 = Control setpoint AN1 (word n° 158) 1 = Control setpoint AN1 (word n° 158) 2 = Control setpoint AN2 (word n° 159) 3 = Control setpoint AN3 (word n° 160) 4 = Control setpoint AN4 (word n° 161)	R/W	TAMP
169	Select source setpoint for control loop 2 0 = Control setpoint AN2 (word n° 159) 1 = Control setpoint AN1 (word n° 158) 2 = Control setpoint AN2 (word n° 159) 3 = Control setpoint AN3 (word n° 160) 4 = Control setpoint AN4 (word n° 161)	R/W	TAMP
170	Select source setpoint for control loop 3 0 = Control setpoint AN3 (word n° 160) 1 = Control setpoint AN1 (word n° 158) 2 = Control setpoint AN2 (word n° 159) 3 = Control setpoint AN3 (word n° 160) 4 = Control setpoint AN4 (word n° 161)	R/W	TAMP
171	Select source setpoint for control loop 4 0 = Control setpoint AN4 (word n° 161) 1 = Control setpoint AN1 (word n° 158) 2 = Control setpoint AN2 (word n° 159) 3 = Control setpoint AN3 (word n° 160) 4 = Control setpoint AN4 (word n° 161)	R/W	TAMP
172	Select PID parameters for control loop 1 0=Chose PID parameters AN1 1= Chose PID parameters AN1 2= Chose PID parameters AN2 3= Chose PID parameters AN3 4= Chose PID parameters AN4	R/W	TAMP

173	Select PID parameters for control loop 2 0=Chose PID parameters AN2 1= Chose PID parameters AN1 2= Chose PID parameters AN2 3= Chose PID parameters AN3 4= Chose PID parameters AN4	R/W	TAMP
174	Select PID parameters for control loop 3 0=Chose PID parameters AN3 1= Chose PID parameters AN1 2= Chose PID parameters AN2 3= Chose PID parameters AN3 4= Chose PID parameters AN4	R/W	TAMP
175	Select PID parameters for control loop 4 0=Chose PID parameters AN4 1= Chose PID parameters AN1 2= Chose PID parameters AN2 3= Chose PID parameters AN3 4= Chose PID parameters AN4	R/W	TAMP
176	Minimum % output OUT1 (0.00÷100.00%)	R/W	TAMP
177	Max. % output OUT1 (0.00÷100.00%)	R/W	TAMP
178	Minimum % output OUT2 (0.00÷100.00%)	R/W	TAMP
179	Max. % output OUT2 (0.00÷100.00%)	R/W	TAMP

For details about the options described above, see parameter **P-54**.

WORD			
MODBUS ADDRESS	Description	READ/ WRITE	RESET VALUE
200	Configuration parameter P-01	R/W	EEP
201	Configuration parameter P-02	R/W	EEP
202	Configuration parameter P-03	R/W	EEP
203	Configuration parameter P-04	R/W	EEP
204	Configuration parameter P-05	R/W	EEP
205	Configuration parameter P-06	R/W	EEP
206	Configuration parameter P-07	R/W	EEP
207	Configuration parameter P-08	R/W	EEP
208	Configuration parameter P-09	R/W	EEP
209	Configuration parameter P-10	R/W	EEP
210	Configuration parameter P-11	R/W	EEP
211	Configuration parameter P-12	R/W	EEP
212	Configuration parameter P-13	R/W	EEP
213	Configuration parameter P-14	R/W	EEP
214	Configuration parameter P-15	R/W	EEP
215	Configuration parameter P-16	R/W	EEP
216	Configuration parameter P-17	R/W	EEP
217	Configuration parameter P-18	R/W	EEP
218	Configuration parameter P-19	R/W	EEP
219	Configuration parameter P-20	R/W	EEP
220	Configuration parameter P-21	R/W	EEP
221	Configuration parameter P-22	R/W	EEP
222	Configuration parameter P-23	R/W	EEP
223	Configuration parameter P-24	R/W	EEP
224	Configuration parameter P-25	R/W	EEP
225	Configuration parameter P-26	R/W	EEP
226	Configuration parameter P-27	R/W	EEP
227	Configuration parameter P-28	R/W	EEP
228	Configuration parameter P-29	R/W	EEP
229	Configuration parameter P-30	R/W	EEP
230	Configuration parameter P-31	R/W	EEP
231	Configuration parameter P-32	R/W	EEP
232	Configuration parameter P-33	R/W	EEP
233	Configuration parameter P-34	R/W	EEP
234	Configuration parameter P-35	R/W	EEP
235	Configuration parameter P-36	R/W	EEP
236	Configuration parameter P-37	R/W	EEP
237	Configuration parameter P-38	R/W	EEP

WORD			
MODBUS ADDRESS	Description	READ/ WRITE	RESET VALUE
238	Configuration parameter P-39	R/W	EEP
239	Configuration parameter P-40	R/W	EEP
240	Configuration parameter P-41	R/W	EEP
241	Configuration parameter P-42	R/W	EEP
242	Configuration parameter P-43	R/W	EEP
243	Configuration parameter P-44	R/W	EEP
244	Configuration parameter P-45	R/W	EEP
245	Configuration parameter P-46	R/W	EEP
246	Configuration parameter P-47	R/W	EEP
247	Configuration parameter P-48	R/W	EEP
248	Configuration parameter P-49	R/W	EEP
249	Configuration parameter P-50	R/W	EEP
250	Configuration parameter P-51	R/W	EEP
251	Configuration parameter P-52	R/W	EEP
252	Configuration parameter P-53	R/W	EEP
253	Configuration parameter P-54	R/W	EEP
254	Configuration parameter P-55	R/W	EEP
255	Configuration parameter P-56	R/W	EEP
256	Configuration parameter P-57	R/W	EEP
257	Configuration parameter P-58	R/W	EEP
258	Configuration parameter P-59	R/W	EEP
259	Configuration parameter P-60	R/W	EEP
260	Configuration parameter P-61	R/W	EEP
261	Configuration parameter P-62	R/W	EEP
262	Configuration parameter P-63	R/W	EEP
263	Configuration parameter P-64	R/W	EEP
264	Configuration parameter P-65	R/W	EEP
265	Configuration parameter P-66	R/W	EEP
266	Configuration parameter P-67	R/W	EEP
267	Configuration parameter P-68	R/W	EEP
268	Configuration parameter P-69	R/W	EEP
269	Configuration parameter P-70	R/W	EEP
270	Configuration parameter P-71	R/W	EEP
271	Configuration parameter P-72	R/W	EEP
272	Configuration parameter P-73	R/W	EEP
273	Configuration parameter P-74	R/W	EEP
274	Configuration parameter P-75	R/W	EEP
275	Configuration parameter P-76	R/W	EEP

WORD			
MODBUS ADDRESS	Description	READ/ WRITE	RESET VALUE
276	Configuration parameter P-77	R/W	EEP
277	Configuration parameter P-78	R/W	EEP
278	Configuration parameter P-79	R/W	EEP
279	Configuration parameter P-80	R/W	EEP
280	Configuration parameter P-81	R/W	EEP

BIT			
MODBUS ADDRESS	DESCRIPTION	READ/ WRITE	RESET VALUE
300	Status digital input I1	R	?
301	Status digital input I2	R	?
302	Status digital input I3	R	?
303	Status digital input I4	R	?
304	Status digital input I5	R	?
305	Status digital input I6	R	?
306	Status digital input I7	R	?
307	Status digital input I8	R	?
308	Status digital input I9	R	?
309	Status digital input I10	R	?
400	Status relay output U1	R	?
401	Status relay output U2	R	?
402	Status relay output U3	R	?
403	Status relay output U4	R	?
404	Status relay output U5	R	?
405	Status relay output U6	R	?
406	Status relay output U7	R	?
407	Status relay output U8	R	?
408	Status relay output U9	R	?
409	Status relay output U10	R	?
410	Status relay output U11	R	?
411	Status relay output U12	R	?
420	Setting relay output U1	R/W	0
421	Setting relay output U2	R/W	0
422	Setting relay output U3	R/W	0
423	Setting relay output U4	R/W	0
424	Setting relay output U5	R/W	0
425	Setting relay output U6	R/W	0
426	Setting relay output U7	R/W	0
427	Setting relay output U8	R/W	0
428	Setting relay output U9	R/W	0
429	Setting relay output U10	R/W	0
430	Setting relay output U11	R/W	0
431	Setting relay output U12	R/W	0
440	Enable modify relay output U1	R/W	0
441	Enable modify relay output U2	R/W	0
442	Enable modify relay output U3	R/W	0
443	Enable modify relay output U4	R/W	0

BIT			
MODBUS ADDRESS	DESCRIZIONE	READ/ WRITE	RESET VALUE
444	Enable modify relay output U5 via serial comm.	R/W	0
445	Enable modify relay output U6 via serial comm.	R/W	0
446	Enable modify relay output U7 via serial comm.	R/W	0
447	Enable modify relay output U8 via serial comm.	R/W	0
448	Enable modify relay output U9 via serial comm.	R/W	0
449	Enable modify relay output U10 via serial comm.	R/W	0
450	Enable modify relay output U11 via serial comm.	R/W	0
451	Enable modify relay output U12 via serial comm.	R/W	0
500	Status alarm no. 1 input AN1	R	?
501	Status alarm no. 2 input AN1	R	?
502	Status alarm no. 1 input AN2	R	?
503	Status alarm no. 2 input AN2	R	?
504	Status alarm no. 1 input AN3	R	?
505	Status alarm no. 2 input AN3	R	?
506	Status alarm no. 1 input AN4	R	?
507	Status alarm no. 2 input AN4	R	?
600	Control Run/stop AN1 (1→Run, 0→Stop)	R/W	TAMP
601	Control Run/stop AN2 (1→Run, 0→Stop)	R/W	TAMP
602	Control Run/stop AN3 (1→Run, 0→Stop)	R/W	TAMP
603	Control Run/stop AN4 (1→Run, 0→Stop)	R/W	TAMP
700	Start auto-tune PID control AN1 (1→Start)	R/W	TAMP
701	Start auto-tune PID control AN2 (1→Start)	R/W	TAMP
702	Start auto-tune PID control AN3 (1→Start)	R/W	TAMP
703	Start auto-tune PID control AN4 (1→Start)	R/W	TAMP

PIXSYS

Via Tagliamento, 18

30030 Mellaredo di Pianiga (VE)

www.pixsys.net

e-mail: sales@pixsys.net - support@pixsys.net

Software Rev. 1.01

2300.10.054-RevA

010704

